

AI56 Acoustic imaging camera



The HIKMICRO AI56 acoustic imaging camera is a professional product for sound source localization. With 64 Low-noise MEMS microphones and an adjustable bandwidth range from 2 kHz to 65 kHz, AI56 provides an easy and effective way to locate pressurized air leaks in industrial environments or detect partial discharge in high-voltage systems. By using a large 4.3" LCD touch screen, the results presented on top of a digital picture allow you to quickly find the source of the problems. The maximum operating distance could reach 100 meters, which can ensure you stay at a safe distance to inspect the high-voltage equipment. By adopting this lightweight and easy-to-use tool, you can discover potential safety risks, minimize troubleshooting, and save extra costs of equipment failures and downtime.

Key Features

- 64 Low-noise MEMS Microphones, Real-time Sound Visualization
- Supports multiple palettes
- High quality optical module with 5 MP resolution
- High-calibre 800 x 480 resolution 4.3" LCD touch display
- Supports 1.0x to 8.0x continuous digital zoom

▪ Specification

Acoustic	
Number of Microphones	64
Acoustic Image Resolution	800 × 480
Bandwidth	2 kHz to 65 kHz
Distance	0.3 m to 100 m
Acoustic Image Palette	8: White Black, Black White, Rainbow, Fusion, Ironbow, Red Black, Rain, Blue Red
Camera FOV	51.8°× 36.4°
Sound Intensity Display	Peak Point, Center Point
Acoustic Image Frame Rate	25 fps
Signal Noise Ratio	70dB
Leak Rate	>0.008 l/min @ 6 bar from 0.5 m (1.64 ft) >0.013 l/min @ 5 bar from 1 m (3.28 ft)
Image Display	
Display	800 × 480 Resolution, 4.3" LCD Touch Screen
Screen Brightness	Manual/Auto
Digital Zoom	1.0x to 8.0x continuous
Data Storage and Communication	
Storage Media	Removable 64 GB SD Card
Image Storage Capacity	20,000 images
Annotations	Voice note: max. 60 seconds; Text note: max. 200 characters
Video Storage Capacity	60 hours
Video File Format	MP4
General	
Wi-Fi	802.11 b/g/n (2.4 GHz and 5 GHz)
Bluetooth	Bluetooth 4.1
USB Interface	USB Type-C
HDMI Interface	HDMI-D
Battery Operating Time	Approx. 3.5 hours
Battery Type	Dismountable and Rechargeable Li-ion Battery
Battery Charging Time	5 hours to full charge
Protection level	IP40
Power Supply	5V DC/2A (Charging via USB)
Drop Test Height	1.2 m (3.94 ft)
Safety	IEC 61010-1
EMC	EN 55032, EN 50130-4, EN IEC 61000-3-2, EN 61000-3-3
Working Temperature Range	-20 °C to 50 °C (-4 °F to 122 °F)
Storage Temperature Range	-20 °C to 60 °C (-4 °F to 140 °F)
Relative Humidity	< 95 % non-condensing
Weight	Approx. 940 g (2.07 lb)
Dimension	292.2 × 127 × 110.7 mm (11.50 × 5.00 × 4.36 in)
Tripod Mounting	UNC ¼"-20

▪ Available Model



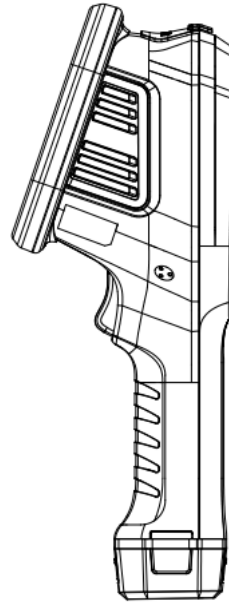
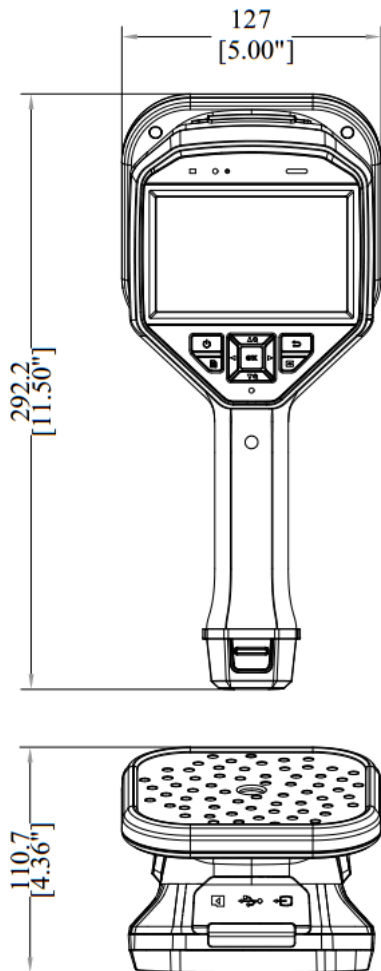

AI56

▪ Dimension



Unit: mm[Inch]



 HIKMICRO Thermography  hikmicro_thermography  HIKMICRO Thermography  HIKMICRO  info@hikmicrotech.com  <http://hikmicrotech.com/en>

© 2023 Hangzhou HIKMICRO Sensing Technology Co., Ltd. All Rights Reserved.
Data subject to change without notice!